

# SINEAX DME 424/442

## Programmable multi-transducers



for the measurement of electrical variables in heavy-current power systems



### Application

The SINEAX DME 4 series of multi-transducers (Fig. 1) **simultaneously** measure several variables of an electric power system and process them to produce 2 resp. 4 analogue output signals. 2 or 4 digital outputs are available for signalling limits or energy metering. For two of the limit outputs up to three measurands can be logically combined.

The multi-transducers are also equipped with an **RS 232** serial interface to which a PC with the corresponding software can be connected for programming or accessing and executing useful ancillary functions.

The usual modes of connection, the types of measured variables, their ratings, the transfer characteristic for each output etc. are the main parameters that have to be programmed.

Ancillary functions include a power system check, provision for displaying the measured variably on a PC monitor, the simulation of the outputs for test purposes and a facility for printing nameplates. The transducer fulfils all the essential requirements and regulations concerning electromagnetic compatibility (**EMC**) and **safety** (IEC 1010 resp. EN 61 010). It was developed and is manufactured and tested in strict accordance with the **quality assurance standard** ISO 9001.

### Features / Benefits

- Simultaneous measurement of several variables of a heavy-current power system / full supervision of an asymmetrically loaded four-wire power system, rated current 1 to 6 A, rated voltage 57 to 400 V (phase-to-neutral) or 100 to 693 V (phase-to-phase)

Measured variables	Output	Types
Current, voltage (rms), active/reactive/apparent power $\cos\phi$ , $\sin\phi$ , power factor RMS value of the current with wire setting range (bimetal measuring function) Slave pointer function for the measurement of the RMS value IB Frequency Average value of the currents with sign of the active power (power system only)	2 analogue outputs and 4 digital outputs or 4 analogue outputs and 2 digital outputs	DME 424
		DME 442
	Data bus LON see data sheet DME 400-1 Le	DME 400
	4 analogue outputs and bus RS 485 (MODBUS) see data sheet DME 440-1 Le	DME 440
	Without analogue outputs, with bus RS 485 (MODBUS) see data sheet DME 401-1 Le	DME 401
	PROFIBUS DP see data sheet DME 406-1 Le	DME 406

- For all heavy-current power system variables
- Up to 6 outputs (2A + 4D or 4A + 2D)
- Input voltage up to 693 V (phase-to-phase)
- Universal analogue outputs (programmable)
- High accuracy: U/I 0.2% and P 0.25% (under reference conditions)
- Universal digital outputs (meter transmitter, limits)

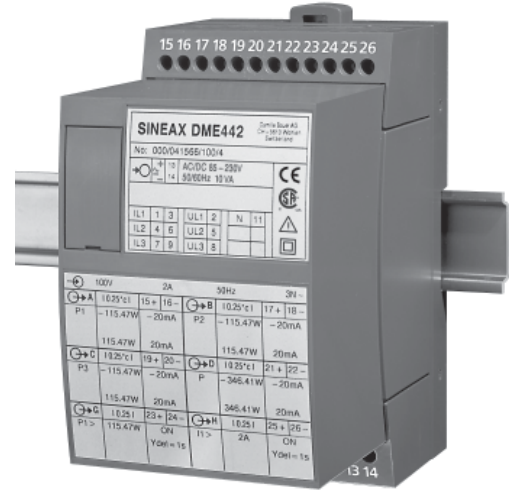

Fig. 1. The **universal** basic version SINEAX DME 442 in housing T24, clipped onto a top-hat rail.

- Up to 2 or 4 integrated energy meters, storage every each 203 s, storage for: 20 years
- Windows software with password protection for programming, data analysis, power system status simulation, acquisition of meter data and making settings
- AC/DC power supply / universal
- Provision for either snapping the transducer onto top-hat rails or securing it with screws to a wall or panel

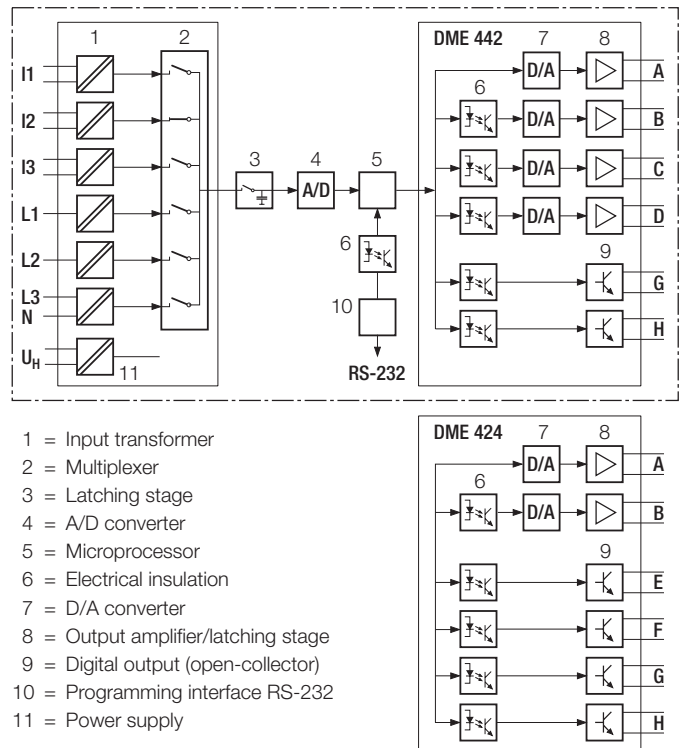

Fig. 2. Block diagram.  
A, B, C, D = analogue outputs; E, F, G, H = digital outputs.

# SINEAX DME 424/442

## Programmable multi-transducers

### Symbols

Symbols	Meaning	Symbols	Meaning
X	Measured variable	Q	Reactive power of the system $Q = Q1 + Q2 + Q3$
X0	Lower limit of the measured variable	Q1	Reactive power phase 1 (phase-to-neutral L1-N)
X1	Break point of the measured variable	Q2	Reactive power phase 2 (phase-to-neutral L2-N)
X2	Upper limit of the measured variable	Q3	Reactive power phase 3 (phase-to-neutral L3-N)
Y	Output variable	S	Apparent power of the system $S = \sqrt{I_1^2 + I_2^2 + I_3^2} \cdot \sqrt{U_1^2 + U_2^2 + U_3^2}$
Y0	Lower limit of the output variable	S1	Apparent power phase 1 (phase-to-neutral L1-N)
Y1	Break point of the output variable	S2	Apparent power phase 2 (phase-to-neutral L2-N)
Y2	Upper limit of the output variable	S3	Apparent power phase 3 (phase-to-neutral L3-N)
U	Input voltage	Sr	Rated value of the apparent power of the system
Ur	Rated value of the input voltage	PF	Active power factor $\cos\varphi = P/S$
U 12	Phase-to-phase voltage L1 – L2	PF1	Active power factor phase 1 P1/S1
U 23	Phase-to-phase voltage L2 – L3	PF2	Active power factor phase 2 P2/S2
U 31	Phase-to-phase voltage L3 – L1	PF3	Active power factor phase 3 P3/S3
U1N	Phase-to-neutral voltage L1 – N	QF	Reactive power factor $\sin\varphi = Q/S$
U2N	Phase-to-neutral voltage L2 – N	QF1	Reactive power factor phase 1 Q1/S1
U3N	Phase-to-neutral voltage L3 – N	QF2	Reactive power factor phase 2 Q2/S2
UM	Average value of the voltages $(U1N + U2N + U3N) / 3$	QF3	Reactive power factor phase 3 Q3/S3
I	Input current	LF	Power factor of the system $LF = \text{sgn}Q \cdot (1 -  PF )$
I1	AC current L1	LF1	Power factor phase 1 $\text{sgn}Q1 \cdot (1 -  PF1 )$
I2	AC current L2	LF2	Power factor phase 2 $\text{sgn}Q2 \cdot (1 -  PF2 )$
I3	AC current L3	LF3	Power factor phase 3 $\text{sgn}Q3 \cdot (1 -  PF3 )$
Ir	Rated value of the input current	c	Factor for the intrinsic error
IM	Average value of the currents $(I1 + I2 + I3) / 3$	R	Output load
IMS	Average value of the currents and sign of the active power (P)	Rn	Rated burden
IB	RMS value of the current with wire setting range (bimetal measuring function)	H	Power supply
IBT	Response time for IB	Hn	Rated value of the power supply
BS	Slave pointer function for the measurement of the RMS value IB	CT	c.t. ratio
BST	Response time for BS	VT	v.t. ratio
$\varphi$	Phase-shift between current and voltage		
F	Frequency of the input variable		
Fn	Rated frequency		
P	Active power of the system $P = P1 + P2 + P3$		
P1	Active power phase 1 (phase-to-neutral L1 – N)		
P2	Active power phase 2 (phase-to-neutral L2 – N)		
P3	Active power phase 3 (phase-to-neutral L3 – N)		

# SINEAX DME 424/442

## Programmable multi-transducers

### Applicable standards and regulations

EN 60 688	Electrical measuring transducers for converting AC electrical variables into analogue and digital signals
IEC 1010 or EN 61 010	Safety regulations for electrical measuring, control and laboratory equipment
EN 60529	Protection types by case (code IP)
IEC 255-4 Part E5	High-frequency interference test (solid-state relays only)
IEC 1000-4-2, 3, 4, 6	Electromagnetic compatibility for industrial-process measurement and control equipment
VDI/VDE 3540, page 2	Reliability of measuring and control equipment (classification of climates)
DIN 40 110	AC quantities
DIN 43 807	Terminal markings
IEC 68 /2-6	Basic environmental testing procedures, vibration, sinusoidal
EN 55011	Electromagnetic compatibility of data processing and telecommunication equipment Limits and measuring principles for radio interference and information equipment
IEC 1036	Solid state AC watt hour meters for active power (Classes 1 and 2)
DIN 43864	Current interface for the transmission of impulses between impulse encoder counter and tariff meter
UL 94	Tests for flammability of plastic materials for parts in devices and appliances

### Technical data

#### Inputs

Input variables:	see Table 2, 4 and 5
Measuring ranges:	see Table 2, 4 and 5
Waveform:	Sinusoidal
Rated frequency:	50...60 Hz; 16 2/3 Hz
Consumption:	Voltage circuit: $\leq U^2 / 400 \text{ k}\Omega$ Condition: external power supply Current circuit: $0.3 \text{ VA} \cdot I/5 \text{ A}$

#### Continuous thermal ratings of inputs

<b>Current circuit</b>	10 A 400 V single-phase AC system 693 V three-phase system
<b>Voltage circuit</b>	480 V single-phase AC system 831 V three-phase system

#### Short-time thermal rating of inputs

Input variable	Number of inputs	Duration of overload	Interval between two overloads
<b>Current circuit</b>	400 V single-phase AC system 693 V three-phase system		
100 A	5	3 s	5 min.
250 A	1	1 s	1 hour
<b>Voltage circuit</b>	1 A, 2 A, 5 A		
Single-phase AC system 600 V $H_{\text{intern}}: 1.5 \text{ Ur}$	10	10 s	10 s
Three-phase system 1040 V $H_{\text{intern}}: 1.5 \text{ Ur}$	10	10 s	10 s

#### Analogue outputs

For the outputs A, B, C and D:

Output variable Y	Impressed DC current	Impressed DC voltage
Full scale Y2	see "Ordering information"	see "Ordering information"
Limits of output signal for input overload and/or $R = 0$	$1.25 \cdot Y2$	40 mA
$R \rightarrow \infty$	30 V	$1.25 Y2$
Rated useful range of output load	$0 \leq \frac{7.5 \text{ V}}{Y2} \leq \frac{15 \text{ V}}{Y2}$	$\frac{Y2}{2 \text{ mA}} \leq \frac{Y2}{1 \text{ mA}} \leq \infty$
AC component of output signal (peak-to-peak)	$\leq 0.005 Y2$	$\leq 0.005 Y2$

The outputs A, B, C and D may be either short or open-circuited. They are electrically insulated from each other and from all other circuits (floating).

# SINEAX DME 424/442

## Programmable multi-transducers

All the full-scale output values can be reduced subsequently using the programming software, but a supplementary error results.

The hardware full-scale settings for the analogue outputs may also be changed subsequently. Conversion of a current to a voltage output or vice versa is also possible. This necessitates changing resistors on the output board. The full-scale values of the current and voltage outputs are set by varying the effective value of two parallel resistors (better resolution). The values of the resistors are selected to achieve the minimum absolute error. Calibration with the programming software is always necessary following conversion of the outputs. Refer to the Operating Instructions. **Caution: The warranty is void if the device is tampered with!**

### Digital outputs, pulse outputs, limit outputs $\rightarrow$

The digital outputs conform to DIN 43 864. The pulse width can be neither programmed nor is there a hardware setting.

Type of contact:	Open collector
Number of pulses:	see "Ordering information"
Pulse duration:	$\geq 100$ ms
Interval:	$\geq 100$ ms
Power supply:	8 ... 40 V
Output current:	ON 10 ... 27 mA OFF $\leq 2$ mA

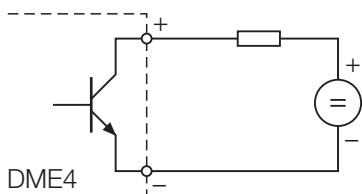

### Reference conditions

Ambient temperature:	15 to 30 °C
Pre-conditioning:	30 min. acc. to EN 60 688 Section 4.3, Table 2
Input variable:	Rated useful range
Power supply:	$H = H_n \pm 1\%$
Active/reactive factor:	$\cos\varphi = 1$ resp. $\sin\varphi = 1$
Frequency:	50 ... 60 Hz, 16 2/3 Hz
Waveform:	Sinusoidal, form factor 1.1107
Output load:	DC current output: $R_n = \frac{7.5 \text{ V}}{Y_2} \pm 1\%$ DC voltage output: $R_n = \frac{Y_2}{1 \text{ mA}} \pm 1\%$
Miscellaneous:	EN 60 688

### System response

Accuracy class: (the reference value is the full-scale value Y2)

Measured variable	Condition	Accuracy class*
<b>System:</b> Active, reactive and apparent power	$0.5 \leq X_2/S_r \leq 1.5$ $0.3 \leq X_2/S_r < 0.5$	0.25 c 0.5 c
<b>Phase:</b> Active, reactive and apparent power	$0.167 \leq X_2/S_r \leq 0.5$ $0.1 \leq X_2/S_r < 0.167$	0.25 c 0.5 c
Power factor, active power factor and reactive power factor	$0.5 S_r \leq S \leq 1.5 S_r$ , $(X_2 - X_0) = 2$	0.25 c
	$0.5 S_r \leq S \leq 1.5 S_r$ , $1 \leq (X_2 - X_0) < 2$	0.5 c
	$0.5 S_r \leq S \leq 1.5 S_r$ , $0.5 \leq (X_2 - X_0) < 1$	1.0 c
	$0.1 S_r \leq S < 0.5 S_r$ , $(X_2 - X_0) = 2$	0.5 c
AC voltage	$0.1 S_r \leq S < 0.5 S_r$ , $1 \leq (X_2 - X_0) < 2$	1.0 c
	$0.1 S_r \leq S < 0.5 S_r$ , $0.5 \leq (X_2 - X_0) < 1$	2.0 c
AC voltage	$0.1 U_r \leq U \leq 1.2 U_r$	0.2 c
AC current/ current averages	$0.1 I_r \leq I \leq 1.5 I_r$	0.2 c
System frequency	$0.1 U_r \leq U \leq 1.2 U_r$ resp. $0.1 I_r \leq I \leq 1.5 I_r$	$0.15 + 0.03$ c ( $f_N = 50 \dots 60$ Hz) $0.15 + 0.1$ c ( $f_N = 16 \text{ 2/3}$ Hz)
Pulse Energy meter	acc. to IEC 1036 $0.1 I_r \leq I \leq 1.5 I_r$	1.0

\* Basic accuracy 0.5 c for applications with phase-shift

Duration of the measurement cycle: Approx. 0.25 to 0.5 s at 50 Hz, depending on measured variable and programming

Response time: 1 ... 2 times the measurement cycle

Factor c (the highest value applies):

Linear characteristic:	$c = \frac{1 - \frac{Y_0}{Y_2}}{1 - \frac{X_0}{X_2}}$ or $c = 1$
Bent characteristic: $X_0 \leq X \leq X_1$	$c = \frac{Y_1 - Y_0}{X_1 - X_0} \cdot \frac{X_2}{Y_2}$ or $c = 1$
$X_1 < X \leq X_2$	$c = \frac{1 - \frac{Y_1}{Y_2}}{1 - \frac{X_1}{X_2}}$ or $c = 1$

# SINEAX DME 424/442

## Programmable multi-transducers

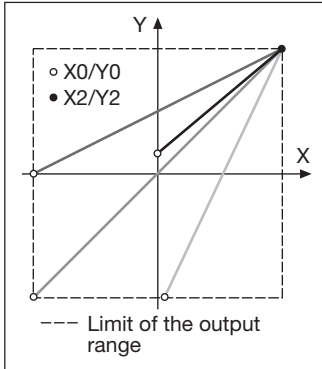

Fig. 3. Examples of settings with linear characteristic.

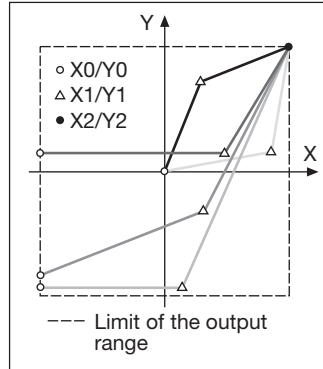

Fig. 4. Examples of settings with bent characteristic.

### Influencing quantities and permissible variations

Acc. to EN 60 688

#### Electrical safety

Protection class:	II
Enclosure protection:	IP 40, housing IP 20, terminals
Installation category:	III
Insulation test (versus earth):	Input voltage: AC 400 V Input current: AC 400 V Output: DC 40 V Power supply: AC 400 V DC 230 V
Surge test:	5 kV; 1.2/50 $\mu$ s; 0.5 Ws
Test voltages:	50 Hz, 1 Min. according to EN 61 010-1 5550 V, inputs versus all other circuits as well as outer surface 3250 V, input circuits versus each other 3700 V, power supply versus outputs and SCI as well as outer surface 490 V, outputs and SCI versus each other and versus outer surface

#### Power supply $\rightarrow$

AC voltage: 100, 110, 230, 400, 500 or 693 V,  $\pm 10\%$ , 45 to 65 Hz  
Power consumption approx. 10 VA

AC/DC power pack (DC and 50 ... 60 Hz)

Table 1: Rated voltages and tolerances

Rated voltage $U_N$	Tolerance
24 ... 60 V DC/AC	DC - 15 ... + 33%
85 ... 230 V DC/AC	AC $\pm 10\%$

Consumption:  $\leq 9$  W resp.  $\leq 10$  VA

#### Programming connector on transducer

Interface: RS 232 C

DSUB socket: 9-pin

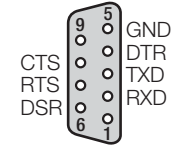

The interface is electrically insulated from all other circuits

#### Installation data

Housing: Housing **T24**  
See Section "Dimensioned drawings"

Housing material: Lexan 940 (polycarbonate), flammability class V-0 acc. to UL 94, self-extinguishing, non-dripping, free of halogen

Mounting: For snapping onto top-hat rail (35 x 15 mm or 35 x 7.5 mm) acc. to EN 50 022  
or  
directly onto a wall or panel using the pull-out screw hole brackets

Orientation: Any

Weight: With supply transformer approx. 1.1 kg  
With AC/DC power pack approx. 0.7 kg

#### Terminals

Type: Screw terminals with wire guards  
Max. wire gauge:  $\leq 4.0$  mm<sup>2</sup> single wire or 2 x 2.5 mm<sup>2</sup> fine wire

#### Vibration withstand

(tested according to DIN EN 60 068-2-6)

Acceleration:  $\pm 2$  g  
Frequency range: 10 ... 150 ... 10 Hz, rate of frequency sweep: 1 octave/minute  
Number of cycles: 10 in each of the three axes  
Result: No faults occurred, no loss of accuracy and no problems with the snap fastener

#### Ambient conditions

Variations due to ambient temperature:  $\pm 0.1\%$  / 10 K  
Nominal range of use for temperature: 0 ... 15 ... 30 ... 45 °C (usage group II)  
Operating temperature: -10 to +55 °C  
Storage temperature: -40 to +85 °C  
Annual mean relative humidity:  $\leq 75\%$   
Altitude: 2000 m max.  
Indoor use statement

# SINEAX DME 424/442

## Programmable multi-transducers

**Table 2: Ordering information for SINEAX DME 424 with 2 analogue and 4 digital outputs**

DESCRIPTION	MARKING
<b>1. Mechanical design</b> Housing T24 for rail and wall mounting	424 - 1
<b>2. Rated frequency</b>	
1) 50 Hz (60 Hz possible without additional error; 16 2/3 Hz, additional error 1.25 · c)	1
2) 60 Hz (50 Hz possible without additional error; 16 2/3 Hz, additional error 1.25 · c)	2
3) 16 2/3 Hz (not re-programming by user, 50/60 Hz possible, but with additional error 1.25 · c)	3
<b>3. Power supply</b>	
Nominal range	
1) AC 90 ... 110 V $H_n = 100$ V	1
2) AC 99 ... 121 V $H_n = 110$ V	2
3) AC 207 ... 253 V $H_n = 230$ V	3
4) AC 360 ... 440 V $H_n = 400$ V	4
5) AC 450 ... 550 V $H_n = 500$ V	5
6) AC 623 ... 762 V $H_n = 693$ V	6
7) DC/AC 24 ... 60 V CSA approved	7
8) DC/AC 85 ... 230 V CSA approved	8
<b>4. Power supply connection</b>	
1) External (standard)	1
2) External or internal from voltage input (not allowed for CSA)	2
Line 2: Not available for rated frequency 16 2/3 Hz and applications A15 / A16 / A24 (see Table 5) Caution: The power supply voltage must agree with the input voltage (Table 5)	
<b>5. Full-scale output signal, output A</b>	
1) Output A, Y2 = 20 mA (standard)	1
9) Output A, Y2 [mA]	9
Z) Output A, Y2 [V]	Z
Line 9: Full-scale current Y2 [mA] 1 to 20 Line Z: Full-scale voltage Y2 [V] 1 to 10	
<b>6. Full-scale output signal, output B</b>	
1) Output B, Y2 = 20 mA (standard)	1
9) Output B, Y2 [mA]	9
Z) Output B, Y2 [V]	Z
<b>7. Test certificate</b>	
0) None supplied	0
1) Supplied	1
<b>8. Programming</b>	
0) Basic	0
9) According to specification	9
Line 0: Not available if the power supply is taken from the voltage input Line 9: <b>All the programming data must be entered on Form W 2386e (see appendix 1) and the form must be included with the order.</b>	



# SINEAX DME 424/442

## Programmable multi-transducers

**Table 3: SINEAX DME 442, standard version (4 analogue and 2 digital outputs)**

The two versions of the transducer below with the **basic** programming are available ex stock. It is only necessary to quote the **Order No.:**

Description / Basic programming		Marking	Order No.
Mechanical design:	Housing T24 for rail and wall mounting	442 - 1	
Rated frequency:	50 Hz (60 Hz admissible without additional error, re-programming by user for 16 2/3 Hz possible, but with additional error 1,25 · c)	1	
<b>Power supply:</b>	<b>230 V AC</b>	<b>3</b>	<b>129 206</b>
	<b>85...230 V DC/AC</b>	<b>8</b>	<b>129 214</b>
Power supply:	External connection (standard)	1	
Full-scale output signal, output A:	Y2 = 20 mA	1	
Full-scale output signal, output B:	Y2 = 20 mA	1	
Full-scale output signal, output C:	Y2 = 20 mA	1	
Full-scale output signal, output D:	Y2 = 20 mA	1	
Test certificate:	None supplied	0	
Programming:	Basic	0	
See Table 4: "Ordering information for SINEAX DME 442 with 4 analogue and 2 digital outputs"			
<b>Basic programming</b>			
Application:	4-wire, 3-phase system, asymmetric load (NPS)	A 44	
Input voltage:	Design value $U_r = 100\text{ V}$	U 21	
Input current:	Design value $I_r = 2\text{ A}$ without specification of primary ratings	V 2 W0	
Measured variable, output A:	P1; $X_0 = 115.47\text{ W}$ ; $X_2 = 115.47\text{ W}$	AA 913	
Output signal, output A:	<b>DC current <math>Y_0 = -20\text{ mA}</math>; <math>Y_2 = 20\text{ mA}</math></b> Linear characteristic Standard limits	AB 91 AC 01 AD 01	
Measured variable, output B:	P2; $X_0 = -115.47$ ; $X_2 = 115.47\text{ W}$	BA 914	
Output signal, output B:	<b>DC current <math>Y_0 = -20\text{ mA}</math>; <math>Y_2 = 20\text{ mA}</math></b> Linear characteristic Standard limits	BB 91 BC 01 BD 01	
Measured variable, output C:	P3; $X_0 = 115.47\text{ W}$ ; $X_2 = 115.47\text{ W}$	CA 915	
Output signal, output C:	<b>DC current <math>Y_0 = -20\text{ mA}</math>; <math>Y_2 = 20\text{ mA}</math></b> Linear characteristic Standard limits	CB 91 CC 01 CD 01	
Measured variable, output D:	P; $X_0 = -346.41$ ; $X_2 = 346.41\text{ W}$	DA 912	
Output signal, output D:	<b>DC current <math>Y_0 = -20\text{ mA}</math>; <math>Y_2 = 20\text{ mA}</math></b> Linear characteristic Standard limits	DB 91 DC 01 DD 01	
Measured variable, output G:	Limit P1; $X_I = 115.47\text{ W}$ Output ON if $X > X_I$ Min. pick-up delay	GA 913 GB 01 GC 01	
Measured variable, output H:	Limit I1; $X_I = 2\text{ A}$ Output ON if $X > X_I$ Min. pick-up delay	HA 909 HB 01 HC 01	

The complete Order Code 442-1... .. according to "Table 4: Ordering information for SINEAX DME 442" should be stated for other versions.

# SINEAX DME 424/442

## Programmable multi-transducers

**Table 4: Ordering information for SINEAX DME 442 with 4 analogue and 2 digital outputs**  
(see also Table 3: Standard version)

DESCRIPTION	MARKING
<b>1. Mechanical design</b> Housing T24 for rail and wall mounting	442 - 1
<b>2. Rated frequency</b>	
1) 50 Hz (60 Hz possible without additional error; 16 2/3 Hz, additional error 1.25 · c)	1
2) 60 Hz (50 Hz possible without additional error; 16 2/3 Hz, additional error 1.25 · c)	2
3) 16 2/3 Hz (not re-programming by user, 50/60 Hz possible, but with additional error 1.25 · c)	3
<b>3. Power supply</b>	
Nominal range	
1) AC 90 ... 110 V $H_n = 100$ V	1
2) AC 99 ... 121 V $H_n = 110$ V	2
3) AC 207 ... 253 V $H_n = 230$ V	3
4) AC 360 ... 440 V $H_n = 400$ V	4
5) AC 450 ... 550 V $H_n = 500$ V	5
6) AC 623 ... 762 V $H_n = 693$ V	6
7) DC/AC 24 ... 60 V CSA approved	7
8) DC/AC 85 ... 230 V CSA approved	8
<b>4. Power supply connection</b>	
1) External (standard)	1
2) Internal from voltage input (not allowed for CSA)	2
Line 2: Not available for rated frequency 16 2/3 Hz and applications A15 / A16 / A24 (see Table 5)	
Caution: The power supply voltage must agree with the input voltage (Table 5)!	
<b>5. Full-scale output signal, output A</b>	
1) Output A, Y2 = 20 mA (standard)	1
9) Output A, Y2 [mA]	9
Z) Output A, Y2 [V]	Z
Line 9: Full-scale current Y2 [mA] 1 to 20	
Line Z: Full-scale voltage Y2 [V] 1 to 10	
<b>6. Full-scale output signal, output B</b>	
1) Output B, Y2 = 20 mA (standard)	1
9) Output B, Y2 [mA]	9
Z) Output B, Y2 [V]	Z
<b>7. Full-scale output signal, output C</b>	
1) Output C, Y2 = 20 mA (standard)	1
9) Output C, Y2 [mA]	9
Z) Output C, Y2 [V]	Z
<b>8. Full-scale output signal, output D</b>	
1) Output D, Y2 = 20 mA (standard)	1
9) Output D, Y2 [mA]	9
Z) Output D, Y2 [V]	Z
<b>9. Test certificate</b>	
0) None supplied	0
1) Supplied	1
<b>10. Programming</b>	
0) Basic	0
9) According to specification	9
Line 0: Not available if the power supply is taken from the voltage input	
Line 9: <b>All the programming data must be entered on Form W 2387e (see appendix 2) and the form must be included with the order.</b>	



# SINEAX DME 424/442

## Programmable multi-transducers

**Table 5: Programming for types DME 424 and 442**

Description	A11 ... A16	Application A34	A24 / A44
<b>1. Application (system)</b>			
Single-phase AC	A11	—	—
3-wire, 3-phase symmetric load, phase-shift U: L1-L2, I: L1 *	A12	—	—
3-wire, 3-phase symmetric load	A13	—	—
4-wire, 3-phase symmetric load	A14	—	—
3-wire, 3-phase symmetric load, phase-shift U: L3-L1, I: L1 *	A15	—	—
3-wire, 3-phase symmetric load, phase-shift U: L2-L3, I: L1 *	A16	—	—
3-wire, 3-phase asymmetric load	—	A34	—
4-wire, 3-phase asymmetric load	—	—	A44
4-wire, 3-phase asymmetric load, open Y	—	—	A24
<b>2. Input voltage</b>			
Rated value $U_r = 57.7$ V	U01	—	—
Rated value $U_r = 63.5$ V	U02	—	—
Rated value $U_r = 100$ V	U03	—	—
Rated value $U_r = 110$ V	U04	—	—
Rated value $U_r = 120$ V	U05	—	—
Rated value $U_r = 230$ V	U06	—	—
Rated value $U_r$ [V] <span style="background-color: #cccccc; display: inline-block; width: 50px; height: 1em; vertical-align: middle;"></span>	U91	—	—
Rated value $U_r = 100$ V	U21	U21	U21
Rated value $U_r = 110$ V	U22	U22	U22
Rated value $U_r = 115$ V	U23	U23	U23
Rated value $U_r = 120$ V	U24	U24	U24
Rated value $U_r = 400$ V	U25	U25	U25
Rated value $U_r = 500$ V	U26	U26	U26
Rated value $U_r$ [V] <span style="background-color: #cccccc; display: inline-block; width: 50px; height: 1em; vertical-align: middle;"></span>	U93	U93	U93
Lines U01 to U06: Only for single phase AC current or 4-wire, 3-phase symmetric load			
Line U91: $U_r$ [V] 57 to 400			
Line U93: $U_r$ [V] > 100 to 693			
<b>3. Input current</b>			
Rated value $I_r = 1$ A	V1	V1	V1
Rated value $I_r = 2$ A	V2	V2	V2
Rated value $I_r = 5$ A	V3	V3	V3
Rated value $I_r > 1$ to 6 [A] <span style="background-color: #cccccc; display: inline-block; width: 50px; height: 1em; vertical-align: middle;"></span>	V9	V9	V9
<b>4. Primary rating (primary transformer)</b>			
Without specification of primary rating	W0	W0	W0
CT = <span style="background-color: #cccccc; display: inline-block; width: 30px; height: 1em; vertical-align: middle;"></span> A / <span style="background-color: #cccccc; display: inline-block; width: 30px; height: 1em; vertical-align: middle;"></span> A VT = <span style="background-color: #cccccc; display: inline-block; width: 30px; height: 1em; vertical-align: middle;"></span> kV / <span style="background-color: #cccccc; display: inline-block; width: 30px; height: 1em; vertical-align: middle;"></span> V	W9	W9	W9
Line W9: Specify transformer ratio prim./sec., e.g. 1000/5 A; 33 kV/110 V			

\* Basic accuracy 0.5 c

Table 5 continued on next page!

# SINEAX DME 424/442

## Programmable multi-transducers

Continuation "Table 5: Programming for types DME 424 and 442"

Description				A11 ... A16	Application A34	A24 / A44
<b>5. Measured variable, output A</b>						
Not used				AA000	AA000	AA000
		initial value X0	final value X2			
U	System	X0 = 0	X2 = Ur*	AA001	—	—
U12	L1-L2	X0 = 0	X2 = Ur*	—	AA001	AA001
U	System	0 ≤ X0 ≤ 0.9 · X2	0.8 · Ur ≤ X2 ≤ 1.2 · Ur*	AA901	—	—
U1N	L1-N	0 ≤ X0 ≤ 0.9 · X2	0.8 · Ur/√3 ≤ X2 ≤ 1.2 · Ur/√3 *	—	—	AA902
U2N	L2-N	0 ≤ X0 ≤ 0.9 · X2	0.8 · Ur/√3 ≤ X2 ≤ 1.2 · Ur/√3 *	—	—	AA903
U3N	L3-N	0 ≤ X0 ≤ 0.9 · X2	0.8 · Ur/√3 ≤ X2 ≤ 1.2 · Ur/√3 *	—	—	AA904
U12	L1-L2	0 ≤ X0 ≤ 0.9 · X2	0.8 · Ur ≤ X2 ≤ 1.2 · Ur*	—	AA905	AA905
U23	L2-L3	0 ≤ X0 ≤ 0.9 · X2	0.8 · Ur ≤ X2 ≤ 1.2 · Ur*	—	AA906	AA906
U31	L3-L1	0 ≤ X0 ≤ 0.9 · X2	0.8 · Ur ≤ X2 ≤ 1.2 · Ur*	—	AA907	AA907
I	System	0 ≤ X0 ≤ 0.8 · X2	0.5 · Ir ≤ X2 ≤ 1.5 · Ir	AA908	—	—
I1	L1	0 ≤ X0 ≤ 0.8 · X2	0.5 · Ir ≤ X2 ≤ 1.5 · Ir	—	AA909	AA909
I2	L2	0 ≤ X0 ≤ 0.8 · X2	0.5 · Ir ≤ X2 ≤ 1.5 · Ir	—	AA910	AA910
I3	L3	0 ≤ X0 ≤ 0.8 · X2	0.5 · Ir ≤ X2 ≤ 1.5 · Ir	—	AA911	AA911
P	System	-X2 ≤ X0 ≤ 0.8 · X2	0.3 ≤ X2 / Sr ≤ 1.5	AA912	AA912	AA912
P1	L1	-X2 ≤ X0 ≤ 0.8 · X2	0.1 ≤ X2 / Sr ≤ 0.5	—	—	AA913
P2	L2	-X2 ≤ X0 ≤ 0.8 · X2	0.1 ≤ X2 / Sr ≤ 0.5	—	—	AA914
P3	L3	-X2 ≤ X0 ≤ 0.8 · X2	0.1 ≤ X2 / Sr ≤ 0.5	—	—	AA915
Q	System	-X2 ≤ X0 ≤ 0.8 · X2	0.3 ≤ X2 / Sr ≤ 1.5	AA916	AA916	AA916
Q1	L1	-X2 ≤ X0 ≤ 0.8 · X2	0.1 ≤ X2 / Sr ≤ 0.5	—	—	AA917
Q2	L2	-X2 ≤ X0 ≤ 0.8 · X2	0.1 ≤ X2 / Sr ≤ 0.5	—	—	AA918
Q3	L3	-X2 ≤ X0 ≤ 0.8 · X2	0.1 ≤ X2 / Sr ≤ 0.5	—	—	AA919
PF	System	-1 ≤ X0 ≤ (X2 - 0.5)	0 ≤ X2 ≤ 1	AA920	AA920	AA920
PF1	L1	-1 ≤ X0 ≤ (X2 - 0.5)	0 ≤ X2 ≤ 1	—	—	AA921
PF2	L2	-1 ≤ X0 ≤ (X2 - 0.5)	0 ≤ X2 ≤ 1	—	—	AA922
PF3	L3	-1 ≤ X0 ≤ (X2 - 0.5)	0 ≤ X2 ≤ 1	—	—	AA923
QF	System	-1 ≤ X0 ≤ (X2 - 0.5)	0 ≤ X2 ≤ 1	AA924	AA924	AA924
QF1	L1	-1 ≤ X0 ≤ (X2 - 0.5)	0 ≤ X2 ≤ 1	—	—	AA925
QF2	L2	-1 ≤ X0 ≤ (X2 - 0.5)	0 ≤ X2 ≤ 1	—	—	AA926
QF3	L3	-1 ≤ X0 ≤ (X2 - 0.5)	0 ≤ X2 ≤ 1	—	—	AA927
F		15.3 Hz ≤ X0 ≤ X2 - 1 Hz	X0 + 1 Hz ≤ X2 ≤ 65 Hz	AA928	AA928	AA928
S	System	0 ≤ X0 ≤ 0.8 · X2	0.3 ≤ X2 / Sr ≤ 1.5	AA929	AA929	AA929
S1	L1	0 ≤ X0 ≤ 0.8 · X2	0.1 ≤ X2 / Sr ≤ 0.5	—	—	AA930
S2	L2	0 ≤ X0 ≤ 0.8 · X2	0.1 ≤ X2 / Sr ≤ 0.5	—	—	AA931
S3	L3	0 ≤ X0 ≤ 0.8 · X2	0.1 ≤ X2 / Sr ≤ 0.5	—	—	AA932
IM	System	0 ≤ X0 ≤ 0.8 · X2	0.5 · Ir ≤ X2 ≤ 1.5 · Ir	—	AA933	AA933
IMS	System	-X2 ≤ X0 ≤ 0.8 · X2	0.5 · Ir ≤ X2 ≤ 1.5 · Ir	—	AA934	AA934
LF	System	-1 ≤ X0 ≤ (X2 - 0.5)	0 ≤ X2 ≤ 1	AA935	AA935	AA935
LF1	L1	-1 ≤ X0 ≤ (X2 - 0.5)	0 ≤ X2 ≤ 1	—	—	AA936
LF2	L2	-1 ≤ X0 ≤ (X2 - 0.5)	0 ≤ X2 ≤ 1	—	—	AA937
LF3	L3	-1 ≤ X0 ≤ (X2 - 0.5)	0 ≤ X2 ≤ 1	—	—	AA938
IB	System	X0 = 0 1 ≤ IBT ≤ 30 min	0.5 · Ir ≤ X2 ≤ 1.5 · Ir	AA939	—	—
IB1	L1	X0 = 0 1 ≤ IBT ≤ 30 min	0.5 · Ir ≤ X2 ≤ 1.5 · Ir	—	AA940	AA940
IB2	L2	X0 = 0 1 ≤ IBT ≤ 30 min	0.5 · Ir ≤ X2 ≤ 1.5 · Ir	—	AA941	AA941
IB3	L3	X0 = 0 1 ≤ IBT ≤ 30 min	0.5 · Ir ≤ X2 ≤ 1.5 · Ir	—	AA942	AA942
BS	System	X0 = 0 1 ≤ BST ≤ 30 min	0.5 · Ir ≤ X2 ≤ 1.5 · Ir	AA943	—	—
BS1	L1	X0 = 0 1 ≤ BST ≤ 30 min	0.5 · Ir ≤ X2 ≤ 1.5 · Ir	—	AA944	AA944
BS2	L2	X0 = 0 1 ≤ BST ≤ 30 min	0.5 · Ir ≤ X2 ≤ 1.5 · Ir	—	AA945	AA945
BS3	L3	X0 = 0 1 ≤ BST ≤ 30 min	0.5 · Ir ≤ X2 ≤ 1.5 · Ir	—	AA946	AA946
UM	System	0 ≤ X0 ≤ 0.8 · X2	0.8 · Ur ≤ X2 ≤ 1.2 · Ur*	—	—	AA947

\* Where the power supply is taken from the measured voltage, the transmitter only operates in the range  $U = 0.8 Ur \dots 1.2 Ur$  and the specified accuracy is only guaranteed in the range  $U = 0.9 Ur \dots 1.1 Ur$ .

Table 5 continued on next page!

# SINEAX DME 424/442

## Programmable multi-transducers

Continuation "Table 5: Programming for types DME 424 and 442"

Description	Application		
	A11 ... A16	A34	A24 / A44
<b>6. Output signal, output A</b>			
initial value Y0			final value Y2
DC current	Y0 = 0	Y2 = 20 mA	
	$-Y2 \leq Y0 \leq 0.2 \cdot Y2$	$1 \text{ mA} \leq Y2 \leq 20 \text{ mA}$	
DC voltage			
	$-Y2 \leq Y0 \leq 0.2 \cdot Y2$	$1 \text{ V} \leq Y2 \leq 10 \text{ V}$	
<b>7. Characteristic, output A</b>			
Linear			
Bent	$(X0 + 0.015 \cdot X2) \leq X1 \leq 0.985 \cdot X2$	$Y0 \leq Y1 \leq Y2$	
<b>8. Limits, output A</b>			
Standard	$Y_{\min} = Y0 - 0.25 Y2$	$Y_{\max} = 1.25 Y2$	
	$(Y0 - 0.25 Y2) \leq Y_{\min} \leq Y0$	$Y2 \leq Y_{\max} \leq 1.25 Y2$	
<b>9. Measured variable, output B</b>			
Same as output A, but markings start with a capital B	BA ...	BA ...	BA ...
<b>10. Output signal, output B</b>			
Same as output A, but markings start with a capital B	BB ..	BB ..	BB ..
<b>11. Characteristic, output B</b>			
Same as output A, but markings start with a capital B	BC ..	BC ..	BC ..
<b>12. Limits, output B</b>			
Same as output A, but markings start with a capital B	BD ..	BD ..	BD ..
<b>Only for type DME 442</b>			
<b>13. Measured variable, output C</b>			
Same as output A, but markings start with a capital C	CA ...	CA ...	CA ...
<b>14. Output signal, output C</b>			
Same as output A, but markings start with a capital C	CB ..	CB ..	CB ..
<b>15. Characteristic, output C</b>			
Same as output A, but markings start with a capital C	CC ..	CC ..	CC ..
<b>16. Limits, output C</b>			
Same as output A, but markings start with a capital C	CD ..	CD ..	CD ..

Table 5 continued on next page!

# SINEAX DME 424/442

## Programmable multi-transducers

Continuation "Table 5: Programming for types DME 424 and 442"

Description	Application		
	A11 ... A16	A34	A24 / A44
<b>Only for type DME 442</b>			
<b>17. Measured variable, output D</b> Same as output A, but markings start with a capital D	DA ..	DA ..	DA ..
<b>18. Output signal, output D</b> Same as output A, but markings start with a capital D	DB ..	DB ..	DB ..
<b>19. Characteristic, output D</b> Same as output A, but markings start with a capital D	DC ..	DC ..	DC ..
<b>20. Limits, output D</b> Same as output A, but markings start with a capital D	DD ..	DD ..	DD ..
<b>Only for type DME 424</b>			
<b>21. Measured variable, output E</b> Not used	EA000	EA000	EA000
Pulse X0 = 0 Y0 = 0			
I System $0.1 \leq X_i \leq (4800 \cdot 1 \text{ A} / I_r)$ [Imp/Ah]	EA950	—	—
I1 L1 $0.1 \leq X_i \leq (4800 \cdot 1 \text{ A} / I_r)$ [Imp/Ah]	—	EA951	EA951
I2 L2 $0.1 \leq X_i \leq (4800 \cdot 1 \text{ A} / I_r)$ [Imp/Ah]	—	EA952	EA952
I3 L3 $0.1 \leq X_i \leq (4800 \cdot 1 \text{ A} / I_r)$ [Imp/Ah]	—	EA953	EA953
S System $0.1 \leq X_i \leq (4000 \cdot 1 \text{ kVA} / S_r)$ [Imp/kVAh]	EA954	EA954	EA954
S1 L1 $0.3 \leq X_i \leq (12000 \cdot 1 \text{ kVA} / S_r)$ [Imp/kVAh]	—	—	EA955
S2 L2 $0.3 \leq X_i \leq (12000 \cdot 1 \text{ kVA} / S_r)$ [Imp/kVAh]	—	—	EA956
S3 L3 $0.3 \leq X_i \leq (12000 \cdot 1 \text{ kVA} / S_r)$ [Imp/kVAh]	—	—	EA957
P System (incoming) $0.1 \leq X_i \leq (4000 \cdot 1 \text{ kVA} / S_r)$ [Imp/kWh]	EA958	EA958	EA958
P1 L1 (incoming) $0.3 \leq X_i \leq (12000 \cdot 1 \text{ kVA} / S_r)$ [Imp/kWh]	—	—	EA959
P2 L2 (incoming) $0.3 \leq X_i \leq (12000 \cdot 1 \text{ kVA} / S_r)$ [Imp/kWh]	—	—	EA960
P3 L3 (incoming) $0.3 \leq X_i \leq (12000 \cdot 1 \text{ kVA} / S_r)$ [Imp/kWh]	—	—	EA961
Q System (inductive) $0.1 \leq X_i \leq (4000 \cdot 1 \text{ kVA} / S_r)$ [Imp/kvarh]	EA962	EA962	EA962
Q1 L1 (inductive) $0.3 \leq X_i \leq (12000 \cdot 1 \text{ kVA} / S_r)$ [Imp/kvarh]	—	—	EA963
Q2 L2 (inductive) $0.3 \leq X_i \leq (12000 \cdot 1 \text{ kVA} / S_r)$ [Imp/kvarh]	—	—	EA964
Q3 L3 (inductive) $0.3 \leq X_i \leq (12000 \cdot 1 \text{ kVA} / S_r)$ [Imp/kvarh]	—	—	EA965
P System (outgoing) $0.1 \leq X_i \leq (4000 \cdot 1 \text{ kVA} / S_r)$ [Imp/kWh]	EA966	EA966	EA966
P1 L1 (outgoing) $0.3 \leq X_i \leq (12000 \cdot 1 \text{ kVA} / S_r)$ [Imp/kWh]	—	—	EA967
P2 L2 (outgoing) $0.3 \leq X_i \leq (12000 \cdot 1 \text{ kVA} / S_r)$ [Imp/kWh]	—	—	EA968
P3 L3 (outgoing) $0.3 \leq X_i \leq (12000 \cdot 1 \text{ kVA} / S_r)$ [Imp/kWh]	—	—	EA969
Q System (capacitive) $0.1 \leq X_i \leq (4000 \cdot 1 \text{ kVA} / S_r)$ [Imp/kvarh]	EA970	EA970	EA970
Q1 L1 (capacitive) $0.3 \leq X_i \leq (12000 \cdot 1 \text{ kVA} / S_r)$ [Imp/kvarh]	—	—	EA971
Q2 L2 (capacitive) $0.3 \leq X_i \leq (12000 \cdot 1 \text{ kVA} / S_r)$ [Imp/kvarh]	—	—	EA972
Q3 L3 (capacitive) $0.3 \leq X_i \leq (12000 \cdot 1 \text{ kVA} / S_r)$ [Imp/kvarh]	—	—	EA973

Table 5 continued on next page!

# SINEAX DME 424/442

## Programmable multi-transducers

Continuation "Table 5: Programming for types DME 424 and 442"

Description			A11 ... A16	Application A34	A24 / A44
<b>21. Measured variable, output E (continuation)</b>					
<b>Limit contact I</b>					
Limit value XI					
U	System	$0 \leq XI \leq 1.2 \cdot Ur$	EA901	—	—
U1N	L1-N	$0 \leq XI \leq 1.2 \cdot Ur/\sqrt{3}$	—	—	EA902
U2N	L2-N	$0 \leq XI \leq 1.2 \cdot Ur/\sqrt{3}$	—	—	EA903
U3N	L3-N	$0 \leq XI \leq 1.2 \cdot Ur/\sqrt{3}$	—	—	EA904
U12	L1-L2	$0 \leq XI \leq 1.2 \cdot Ur$	—	EA905	EA905
U23	L2-L3	$0 \leq XI \leq 1.2 \cdot Ur$	—	EA906	EA906
U31	L3-L1	$0 \leq XI \leq 1.2 \cdot Ur$	—	EA907	EA907
I	System	$0 \leq XI \leq 1.5 \cdot Ir$	EA908	—	—
I1	L1	$0 \leq XI \leq 1.5 \cdot Ir$	—	EA909	EA909
I2	L2	$0 \leq XI \leq 1.5 \cdot Ir$	—	EA910	EA910
I3	L3	$0 \leq XI \leq 1.5 \cdot Ir$	—	EA911	EA911
P	System	$-1.5 \leq XI / Sr \leq 1.5$	EA912	EA912	EA912
P1	L1	$-0.5 \leq XI / Sr \leq 0.5$	—	—	EA913
P2	L2	$-0.5 \leq XI / Sr \leq 0.5$	—	—	EA914
P3	L3	$-0.5 \leq XI / Sr \leq 0.5$	—	—	EA915
Q	System	$-1.5 \leq XI / Sr \leq 1.5$	EA916	EA916	EA916
Q1	L1	$-0.5 \leq XI / Sr \leq 0.5$	—	—	EA917
Q2	L2	$-0.5 \leq XI / Sr \leq 0.5$	—	—	EA918
Q3	L3	$-0.5 \leq XI / Sr \leq 0.5$	—	—	EA919
PF	System	$-1 \leq XI \leq 1$	EA920	EA920	EA920
PF1	L1	$-1 \leq XI \leq 1$	—	—	EA921
PF2	L2	$-1 \leq XI \leq 1$	—	—	EA922
PF3	L3	$-1 \leq XI \leq 1$	—	—	EA923
QF	System	$-1 \leq XI \leq 1$	EA924	EA924	EA924
QF1	L1	$-1 \leq XI \leq 1$	—	—	EA925
QF2	L2	$-1 \leq XI \leq 1$	—	—	EA926
QF3	L3	$-1 \leq XI \leq 1$	—	—	EA927
F		$15.3 \text{ Hz} \leq XI \leq 65 \text{ Hz}$	EA928	EA928	EA928
S	System	$0 \leq XI / Sr \leq 1.5$	EA929	EA929	EA929
S1	L1	$0 \leq XI / Sr \leq 0.5$	—	—	EA930
S2	L2	$0 \leq XI / Sr \leq 0.5$	—	—	EA931
S3	L3	$0 \leq XI / Sr \leq 0.5$	—	—	EA932
IM	System	$0 \leq XI / Ir \leq 1.5$	—	EA933	EA933
IMS	System	$-1.5 \leq XI / Ir \leq 1.5$	—	EA934	EA934
LF	System	$-1 \leq XI \leq 1$	EA935	EA935	EA935
LF1	L1	$-1 \leq XI \leq 1$	—	—	EA936
LF2	L2	$-1 \leq XI \leq 1$	—	—	EA937
LF3	L3	$-1 \leq XI \leq 1$	—	—	EA938
IB	System	$1 \leq IBT \leq 30 \text{ min}$	$0 \leq XI / Ir \leq 1.5$	EA939	—
IB1	L1	$1 \leq IBT \leq 30 \text{ min}$	$0 \leq XI / Ir \leq 1.5$	—	EA940
IB2	L2	$1 \leq IBT \leq 30 \text{ min}$	$0 \leq XI / Ir \leq 1.5$	—	EA941
IB3	L3	$1 \leq IBT \leq 30 \text{ min}$	$0 \leq XI / Ir \leq 1.5$	—	EA942
BS	System	$1 \leq BST \leq 30 \text{ min}$	$0 \leq XI / Ir \leq 1.5$	EA943	—
BS1	L1	$1 \leq BST \leq 30 \text{ min}$	$0 \leq XI / Ir \leq 1.5$	—	EA944
BS2	L2	$1 \leq BST \leq 30 \text{ min}$	$0 \leq XI / Ir \leq 1.5$	—	EA945
BS3	L3	$1 \leq BST \leq 30 \text{ min}$	$0 \leq XI / Ir \leq 1.5$	—	EA946
UM	System	$0 \leq XI \leq 1.2 \cdot Ur$	—	—	EA947

Table 5 continued on next page!

# SINEAX DME 424/442

## Programmable multi-transducers

Continuation "Table 5: Programming for types DME 424 and 442"

Description	Application		
	A11 ... A16	A34	A24 / A44
<b>22. Output signal, output E</b> (only for EA901 ... EA947) ON if $X1 > X1$ $X1 < X1$ OFF if $X1 < X1$ $X1 > X1$	EB01 EB02	EB01 EB02	EB01 EB02
<b>23. Pick-up delay, output E</b> (only for EA901 ... EA947) Minimum $1 \leq Y \text{ Del} \leq 30 \text{ s}$	EC01 EC91	EC01 EC91	EC01 EC91
<b>Only for type DME 424</b> <b>24. Measured variable, output F</b> Same as output E, but markings start with a capital F	FA ..	FA ..	FA ..
<b>25. Output signal, output F</b> Same as output E, but markings start with a capital F	FB ..	FB ..	FB ..
<b>26. Pick-up delay, output F</b> Same as output E, but markings start with capital F	FC ..	FC ..	FC ..
<b>For types DME 424 and 442</b> <b>27. Measured variable, output G</b> Same as output E, but markings start with a capital G	GA ..	GA ..	GA ..
<b>28. Output signal, output G</b> Same as output E, but markings start with a capital G	GB ..	GB ..	GB ..
<b>29. Pick-up delay, output G</b> Same as output E, but markings start with a capital G	GC ..	GC ..	GC ..
<b>For types DME 424 and 442</b> <b>30. Measured variable, output H</b> Same as output E, but markings start with a capital H	HA ..	HA ..	HA ..
<b>31. Output signal, output H</b> Same as output E, but markings start with a capital H	HB ..	HB ..	HB ..
<b>32. Pick-up delay, output H</b> Same as output E, but markings start with a capital H	HC ..	HC ..	HC ..

Note: Up to three limits can be assigned to digital outputs G and H using the programming software.

# SINEAX DME 424/442

## Programmable multi-transducers

### Electrical connections

Function		Connection			
Meas. input ⊖	AC current	IL1	1 / 3		
		IL2	4 / 6		
		IL3	7 / 9		
	AC voltage	UL1	2		
		UL2	5		
	UL3	8			
	N	11			
Outputs ⊕	Analogue	A	+	15	
			-	16	
		B	+	17	
			-	18	
		C	⊕ E	+	19
			⊕ F	-	20
	D	⊕ G	+	21	
		⊕ H	-	22	
	Digital	G	+	23	
			-	24	
		H	+	25	
			-	26	
Power supply AC ⊖		~	13		
		~	14		
	DC	+	13		
		-	14		

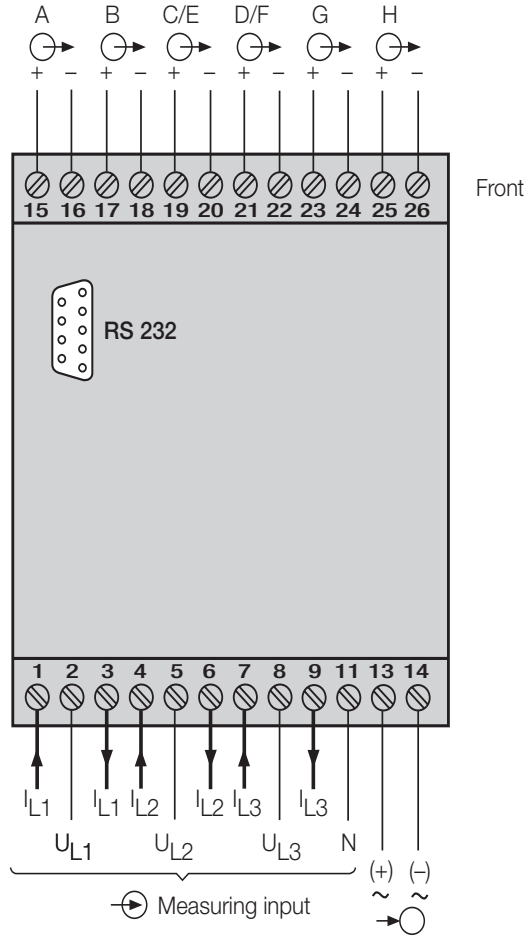

If power supply is taken from the measured voltage internal connections are as follow:

Application (system)	Internal connection Terminal / System
Single phase AC current	2 / 11 (L1 - N)
4-wire 3-phase symmetric load	2 / 11 (L1 - N)
All other (apart from A15 / A16 / A24)	2 / 5 (L1 - L2)

### Measuring input

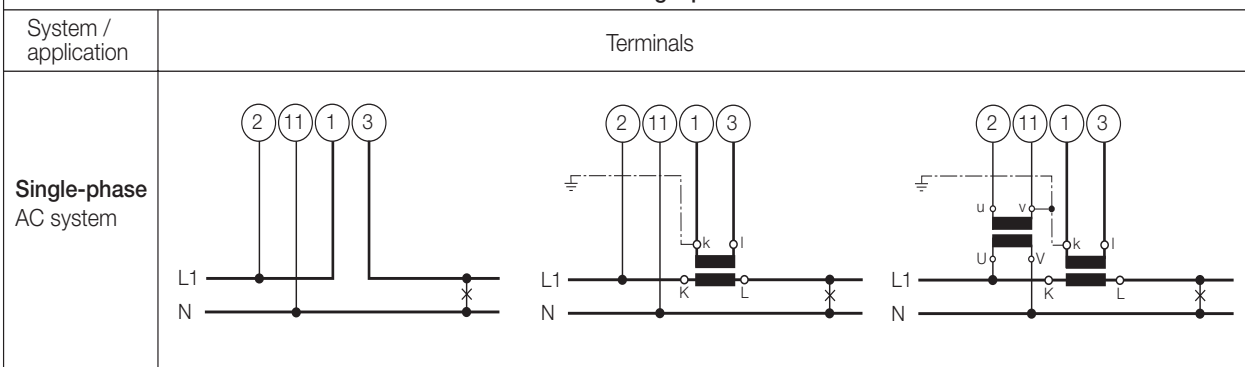



# SINEAX DME 424/442

## Programmable multi-transducers

### Measuring input

System / application

Terminals

**3-wire**  
3-phase  
**symmetric**  
**load**  
I: L1

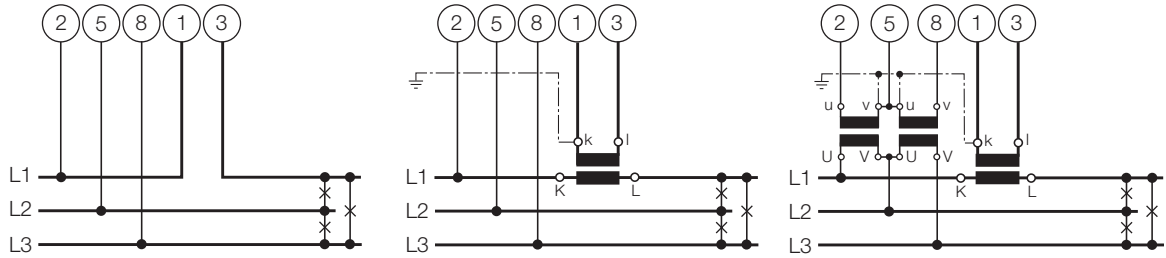

Connect the voltage according to the following table for current measurement in L2 or L3:

Current transformer	Terminals		2	5	8
L2	1	3	L2	L3	L1
L3	1	3	L3	L1	L2

**3-wire**  
3-phase  
**symmetric**  
**load**  
Phase-shift  
U: L1 – L2  
I: L1

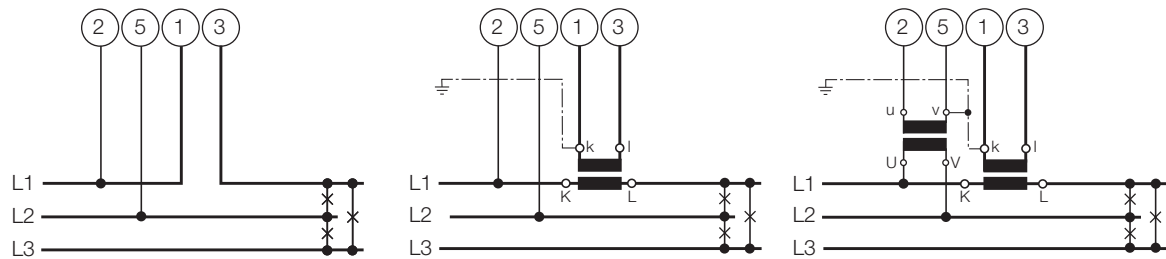

Connect the voltage according to the following table for current measurement in L2 or L3:

Current transformer	Terminals		2	5
L2	1	3	L2	L3
L3	1	3	L3	L1

**3-wire**  
3-phase  
**symmetric**  
**load**  
Phase-shift  
U: L3 – L1  
I: L1

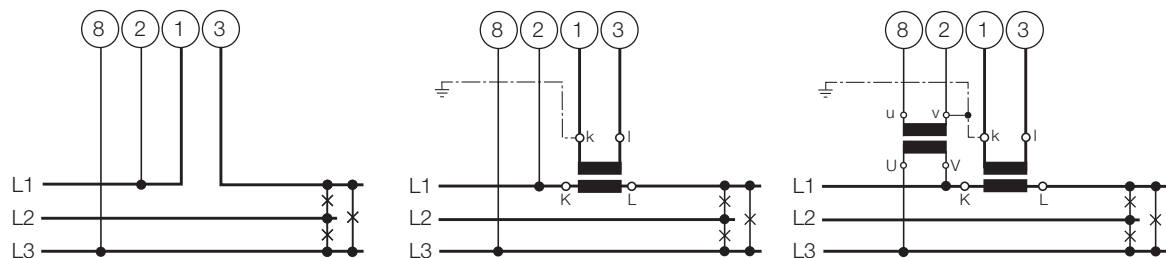

Connect the voltage according to the following table for current measurement in L2 or L3:

Current transformer	Terminals		8	2
L2	1	3	L1	L2
L3	1	3	L2	L3

# SINEAX DME 424/442

## Programmable multi-transducers

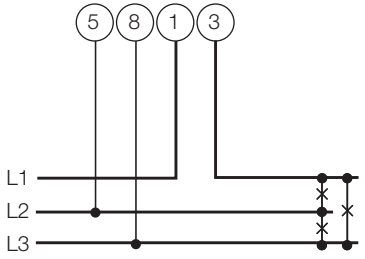
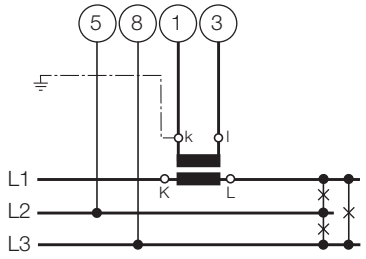
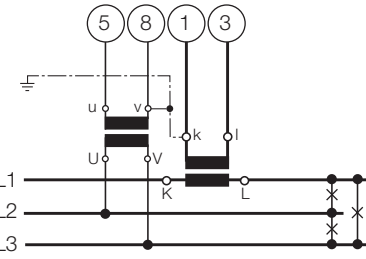
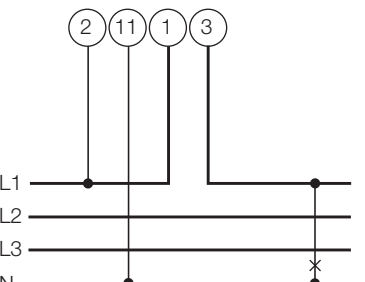
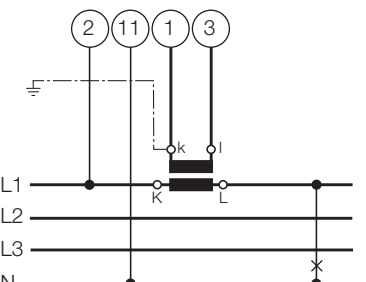
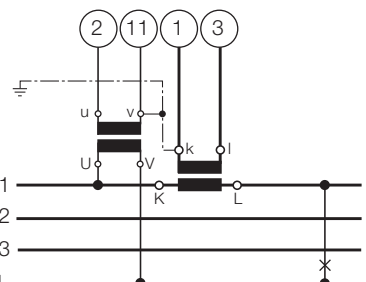
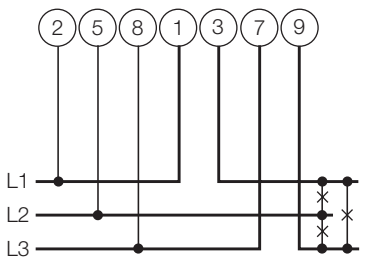
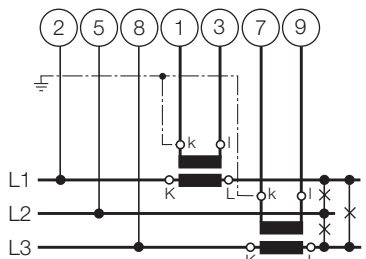
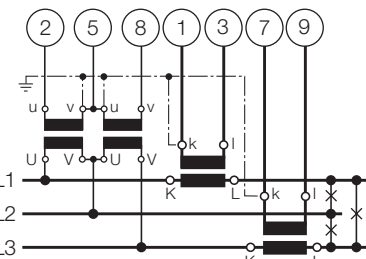
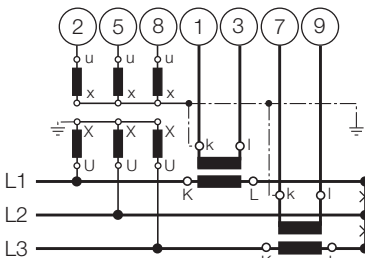
Measuring input																
System / application	Terminals															
<p><b>3-wire</b> 3-phase <b>symmetric load</b> Phase-shift U: L2 – L3 I: L1</p>	<div style="display: flex; justify-content: space-around;">    </div> <p>Connect the voltage according to the following table for current measurement in L2 or L3:</p> <table border="1" style="margin-left: auto; margin-right: auto;"> <thead> <tr> <th>Current transformer</th> <th colspan="2">Terminals</th> <th>5</th> <th>8</th> </tr> </thead> <tbody> <tr> <td>L2</td> <td>1</td> <td>3</td> <td>L3</td> <td>L1</td> </tr> <tr> <td>L3</td> <td>1</td> <td>3</td> <td>L1</td> <td>L2</td> </tr> </tbody> </table>	Current transformer	Terminals		5	8	L2	1	3	L3	L1	L3	1	3	L1	L2
Current transformer	Terminals		5	8												
L2	1	3	L3	L1												
L3	1	3	L1	L2												
<p><b>4-wire</b> 3-phase <b>symmetric load</b> I: L1</p>	<div style="display: flex; justify-content: space-around;">    </div> <p>Connect the voltage according to the following table for current measurement in L2 or L3:</p> <table border="1" style="margin-left: auto; margin-right: auto;"> <thead> <tr> <th>Current transformer</th> <th colspan="2">Terminals</th> <th>2</th> <th>11</th> </tr> </thead> <tbody> <tr> <td>L2</td> <td>1</td> <td>3</td> <td>L2</td> <td>N</td> </tr> <tr> <td>L3</td> <td>1</td> <td>3</td> <td>L3</td> <td>N</td> </tr> </tbody> </table>	Current transformer	Terminals		2	11	L2	1	3	L2	N	L3	1	3	L3	N
Current transformer	Terminals		2	11												
L2	1	3	L2	N												
L3	1	3	L3	N												
<p><b>3-wire</b> 3-phase <b>asymmetric load</b></p>	<div style="display: flex; justify-content: space-around;">    </div> <div style="margin-top: 20px;">  </div>															

# SINEAX DME 424/442

## Programmable multi-transducers

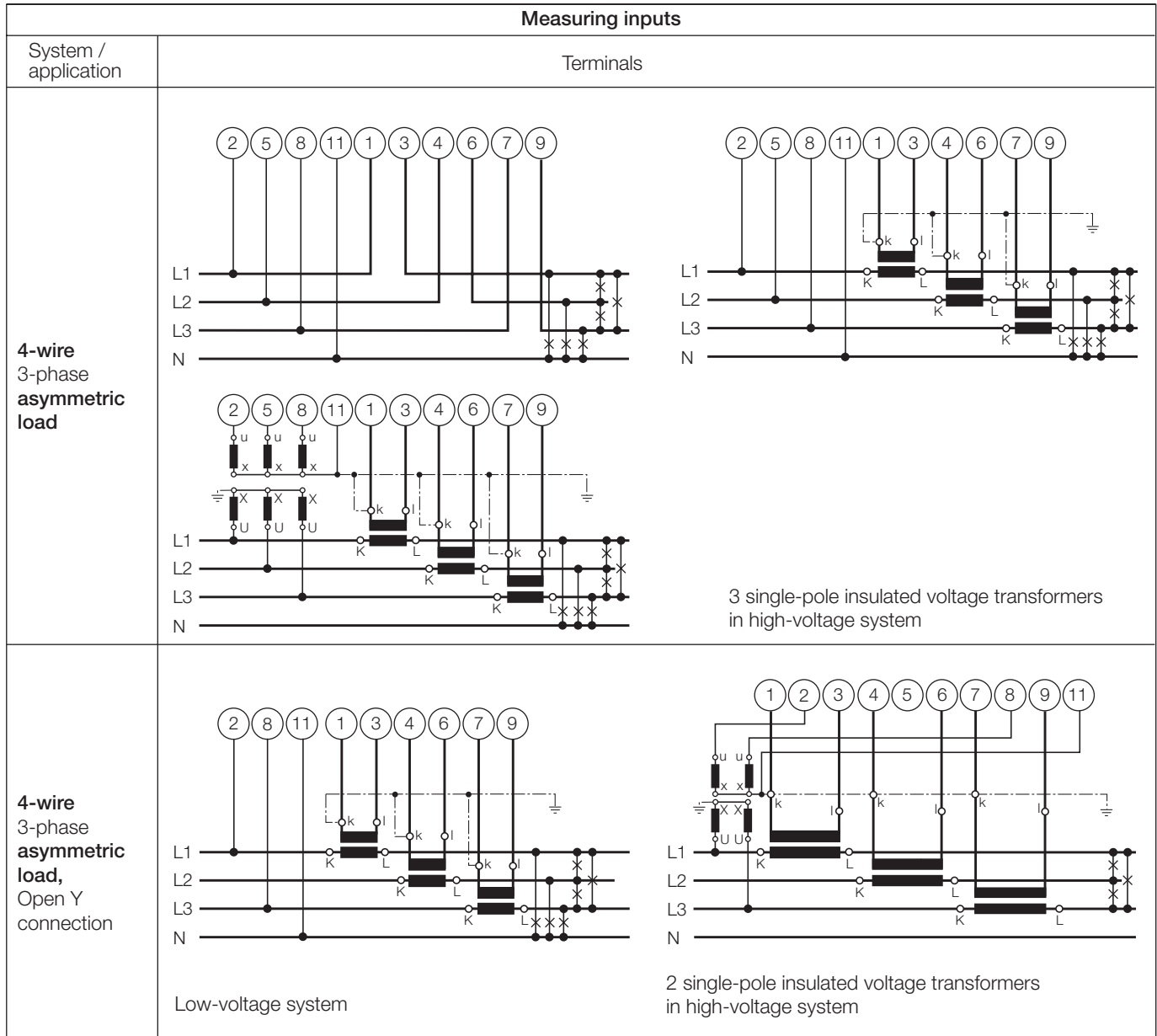

### Relationship between PF, QF and LF

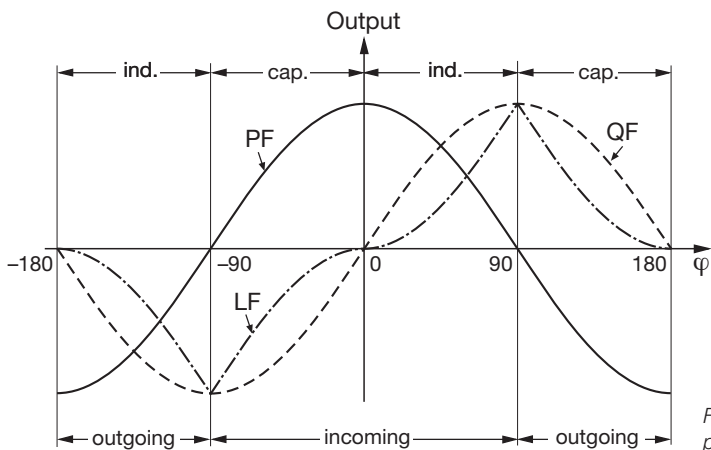

Fig. 5. Active power PF —, reactive power QF -----, power factor LF -.-.-.

# SINEAX DME 424/442

## Programmable multi-transducers

### Dimensioned drawings

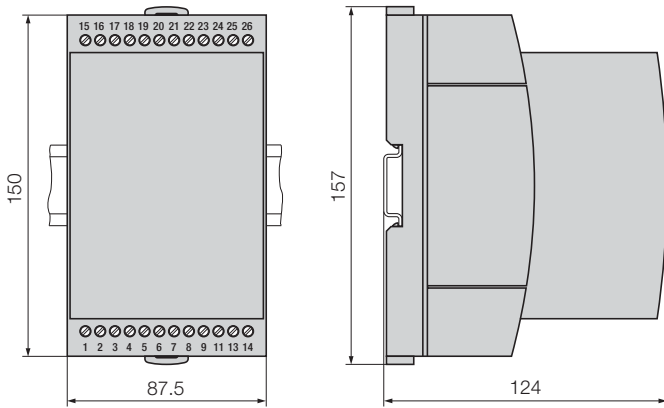

Fig. 6. SINEAX DME 424/442 in housing **T24** clipped onto a top-hat rail (35 x 15 mm or 35 x 7.5 mm, acc. to EN 50 022).

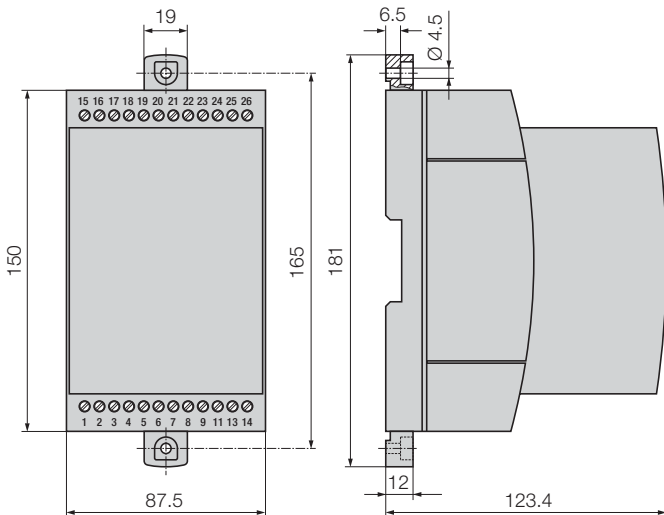

Fig. 7. SINEAX DME 424/442 in housing **T24**, screw hole mounting brackets pulled out.

### Table 6: Accessories

Description	Order No.
<b>Programming cable</b>	980 179
<b>Configuration Software DME 4</b> for SINEAX/EURAX DME 424, 440, 442, SINEAX DME 400, 401 and 406 Windows 3.1x, 95, 98, NT and 2000 on CD in German, English, French, Italian and Dutch <b>(Download free of charge under <a href="http://www.camillebauer.com">http://www.camillebauer.com</a>)</b> In addition, the CD contains all configuration programmes presently available for Camille Bauer products.	146 557
Operating Instructions DME 424/442-1 Bd-f-e	122 250



Description	Order No.
<b>SINEAX A 200</b>	154 063
Interconnecting cable sub D 9 pol. male/male 1.8 m	154 071

### Standard accessories

- 1 Operating Instructions in three languages: German, French, English
- 1 blank type label for recording programmed settings

# Appendix 1: PROGRAMMING FOR SINEAX TYPE DME 424

with 2 analogue and 4 digital outputs

(see Data Sheet DME 424/442-1 Le, Table 5: "Programming for types DME 424 and 442")



Customer / Agent: _____	Date: _____
Order No. / Item: _____	Delivery date: _____
No of instruments: _____	
Type of instrument (marking): _____	

<input type="checkbox"/> A <input type="checkbox"/> <input type="checkbox"/> <input type="checkbox"/>	<b>1. Application</b>	System _____	
<input type="checkbox"/> U <input type="checkbox"/> <input type="checkbox"/> <input type="checkbox"/>	<b>2. Input voltage, rated value</b>	Ur = _____	
<input type="checkbox"/> V <input type="checkbox"/> <input type="checkbox"/>	<b>3. Input current, rated value</b>	Ir = _____	
<input type="checkbox"/> W <input type="checkbox"/> <input type="checkbox"/>	<b>4. Primary transformer</b>	CT = _____ A / _____ A	VT = _____ kV / _____ V
<b>Output A</b>			
<input type="checkbox"/> A <input type="checkbox"/> A <input type="checkbox"/> <input type="checkbox"/> <input type="checkbox"/>	5. Measured variable	Type: _____	X0 = _____ X2 = _____
<input type="checkbox"/> A <input type="checkbox"/> B <input type="checkbox"/> <input type="checkbox"/>	6. Output signal		Y0 = _____ Y2 = _____
<input type="checkbox"/> A <input type="checkbox"/> C <input type="checkbox"/> <input type="checkbox"/>	7. Characteristic linear/bent		X1 = _____ Y1 = _____
<input type="checkbox"/> A <input type="checkbox"/> D <input type="checkbox"/> <input type="checkbox"/>	8. Limits	Standard / Ymin = _____	Ymax = _____
<b>Output B</b>			
<input type="checkbox"/> B <input type="checkbox"/> A <input type="checkbox"/> <input type="checkbox"/> <input type="checkbox"/>	9. Measured variable	Type: _____	X0 = _____ X2 = _____
<input type="checkbox"/> B <input type="checkbox"/> B <input type="checkbox"/> <input type="checkbox"/>	10. Output signal		Y0 = _____ Y2 = _____
<input type="checkbox"/> B <input type="checkbox"/> C <input type="checkbox"/> <input type="checkbox"/>	11. Characteristic linear/bent		X1 = _____ Y1 = _____
<input type="checkbox"/> B <input type="checkbox"/> D <input type="checkbox"/> <input type="checkbox"/>	12. Limits	Standard / Ymin = _____	Ymax = _____
<b>Output E</b>			
<input type="checkbox"/> E <input type="checkbox"/> A <input type="checkbox"/> <input type="checkbox"/> <input type="checkbox"/>	21. Measured variable	Type: _____	Additional information: _____
<input type="checkbox"/> E <input type="checkbox"/> B <input type="checkbox"/> <input type="checkbox"/>	22. Output signal (limit contact only)		ON / OFF
<input type="checkbox"/> E <input type="checkbox"/> C <input type="checkbox"/> <input type="checkbox"/>	23. Pick-up delay		YDel = _____ s
<b>Output F</b>			
<input type="checkbox"/> F <input type="checkbox"/> A <input type="checkbox"/> <input type="checkbox"/> <input type="checkbox"/>	24. Measured variable	Type: _____	Additional information: _____
<input type="checkbox"/> F <input type="checkbox"/> B <input type="checkbox"/> <input type="checkbox"/>	25. Output signal (limit contact only)		ON / OFF
<input type="checkbox"/> F <input type="checkbox"/> C <input type="checkbox"/> <input type="checkbox"/>	26. Pick-up delay		YDel = _____ s

Continued on next page!



**Output G**

G	A			
---	---	--	--	--

27. Measured variable      Type: \_\_\_\_\_

Additional information: \_\_\_\_\_

G	B			
---	---	--	--	--

28. Output signal (limit contact only)

ON / OFF

G	C			
---	---	--	--	--

29. Pick-up delay

YDel = \_\_\_\_\_ s

**Output H**

H	A			
---	---	--	--	--

30. Measured variable      Type: \_\_\_\_\_

Additional information: \_\_\_\_\_

H	B			
---	---	--	--	--

31. Output signal (limit contact only)

ON / OFF

H	C			
---	---	--	--	--

32. Pick-up delay

YDel = \_\_\_\_\_ s

# Appendix 2: PROGRAMMING FOR SINEAX TYPE DME 442

With 4 analogue and 2 digital outputs

(see Data Sheet DME 424/442-1 Le, Table 5: "Programming for types DME 424 and 442")



Customer / Agent: _____	Date: _____
Order No. / Item: _____	Delivery date: _____
No of instruments: _____	
Type of instrument (marking): _____	
_____	

A					<b>1. Application</b>	System _____
U					<b>2. Input voltage, rated value</b>	Ur = _____
V					<b>3. Input current, rated value</b>	Ir = _____
W					<b>4. Primary transformer</b>	CT = _____ A / _____ A      VT = _____ kV / _____ V
A	A				<b>Output A</b>	5. Measured variable    Type: _____    X0 = _____    X2 = _____
A	B				6. Output signal	Y0 = _____    Y2 = _____
A	C				7. Characteristic linear/bent	X1 = _____    Y1 = _____
A	D				8. Limits	Standard / Ymin = _____    Ymax = _____
B	A				<b>Output B</b>	9. Measured variable    Type: _____    X0 = _____    X2 = _____
B	B				10. Output signal	Y0 = _____    Y2 = _____
B	C				11. Characteristic linear/bent	X1 = _____    Y1 = _____
B	D				12. Limits	Standard / Ymin = _____    Ymax = _____
C	A				<b>Output C</b>	13. Measured variable    Type: _____    X0 = _____    X2 = _____
C	B				14. Output signal	Y0 = _____    Y2 = _____
C	C				15. Characteristic linear/bent	X1 = _____    Y1 = _____
C	D				16. Limits	Standard / Ymin = _____    Ymax = _____
D	A				<b>Output D</b>	17. Measured variable    Type: _____    X0 = _____    X2 = _____
D	B				18. Output signal	Y0 = _____    Y2 = _____
D	C				19. Characteristic linear/bent	X1 = _____    Y1 = _____
D	D				20. Limits	Standard / Ymin = _____    Ymax = _____

Continued on next page!





**Output G**

G	A			
---	---	--	--	--

21. Measured variable      Type: \_\_\_\_\_

Additional information: \_\_\_\_\_

G	B			
---	---	--	--	--

22. Output signal (limit contact only)

ON / OFF

G	C			
---	---	--	--	--

23. Pick-up delay

YDel = \_\_\_\_\_ s

**Output H**

H	A			
---	---	--	--	--

24. Measured variable      Type: \_\_\_\_\_

Additional information: \_\_\_\_\_

H	B			
---	---	--	--	--

25. Output signal (limit contact only)

ON / OFF

H	C			
---	---	--	--	--

26. Pick-up delay

YDel = \_\_\_\_\_ s

